

1

2

3

4

A

A

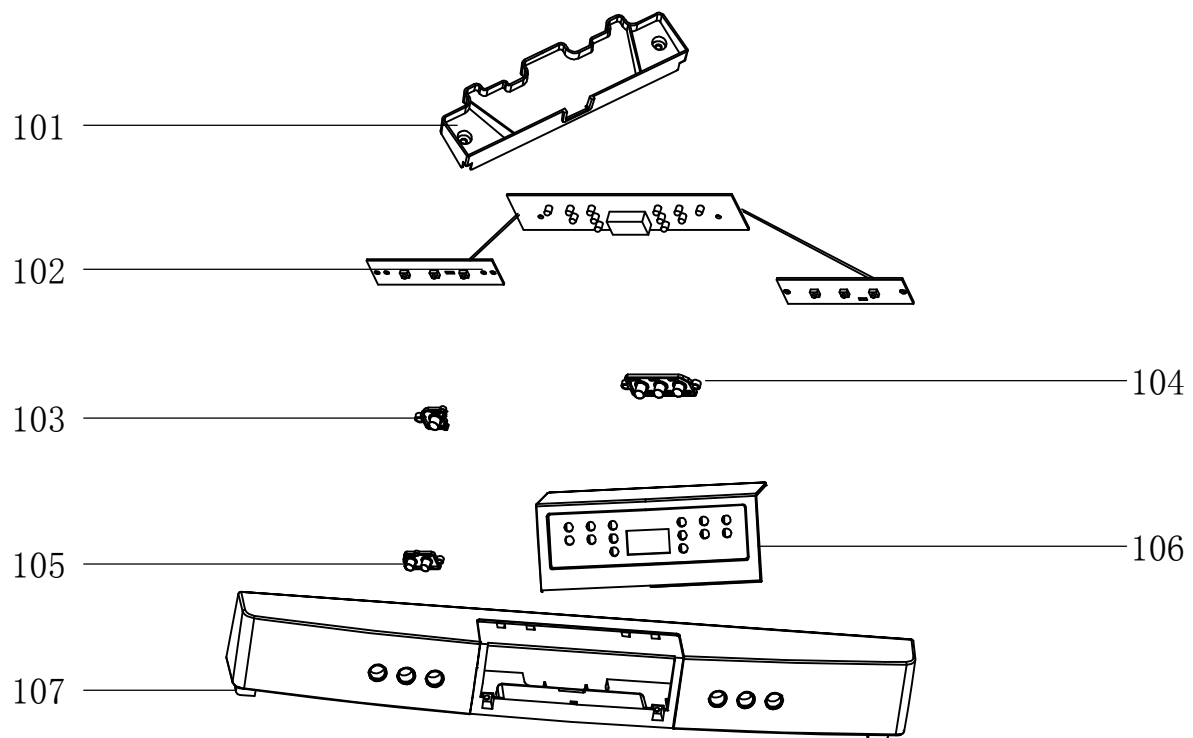

B

B

C

C

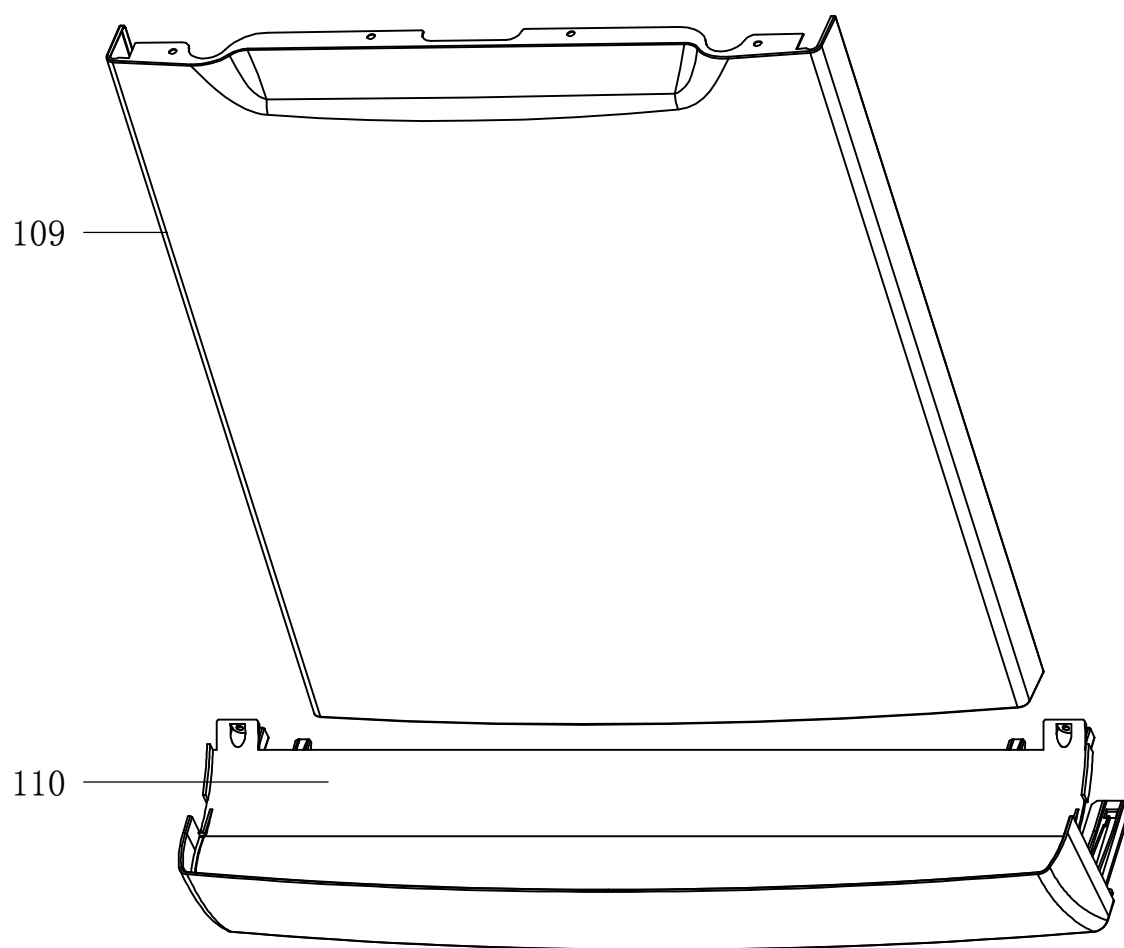

D

D

E

E

F

F

1

2

3

4

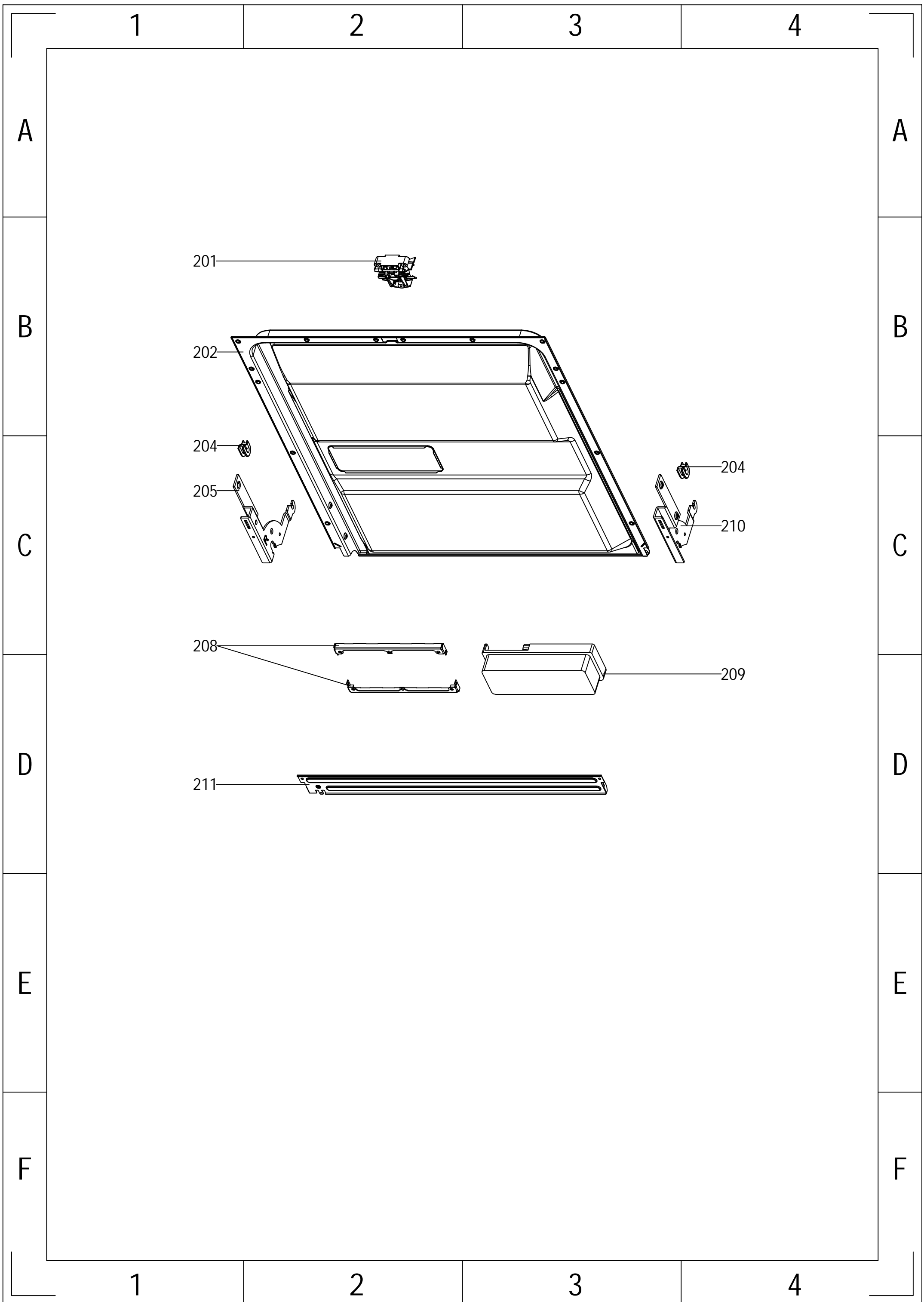

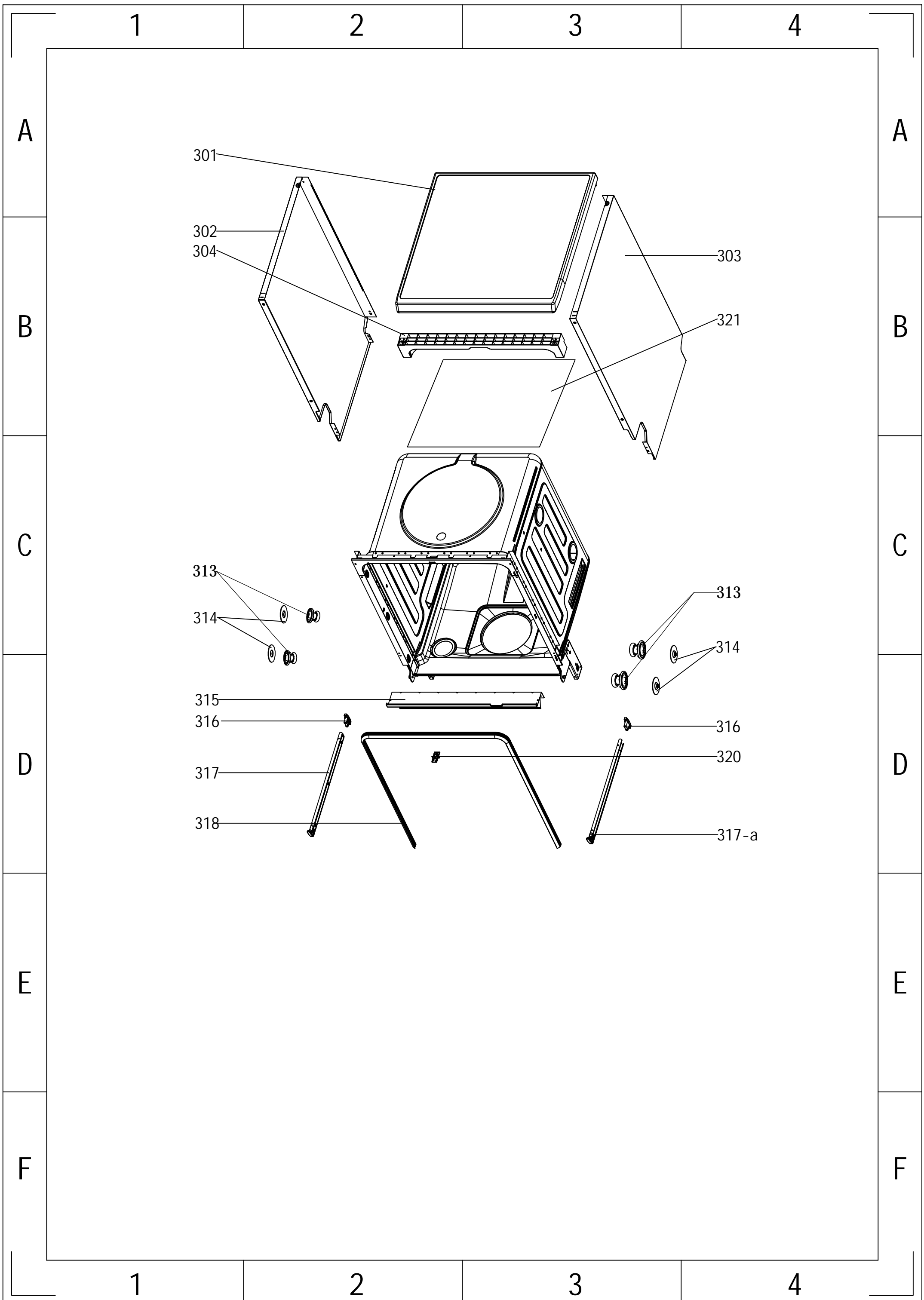

1

2

3

4

A

A

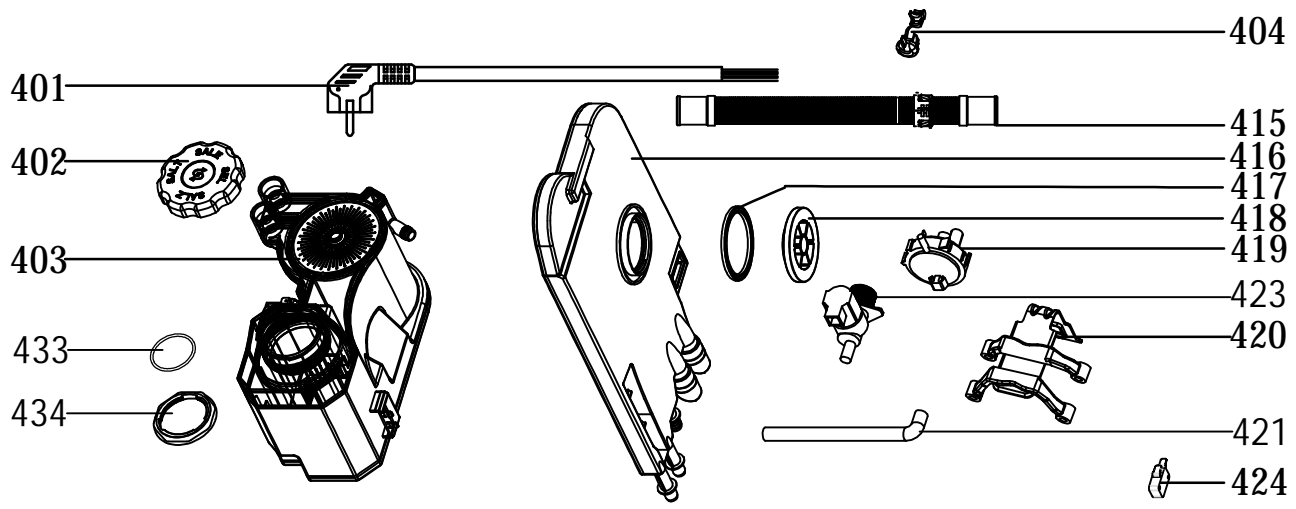

B

B



C

C

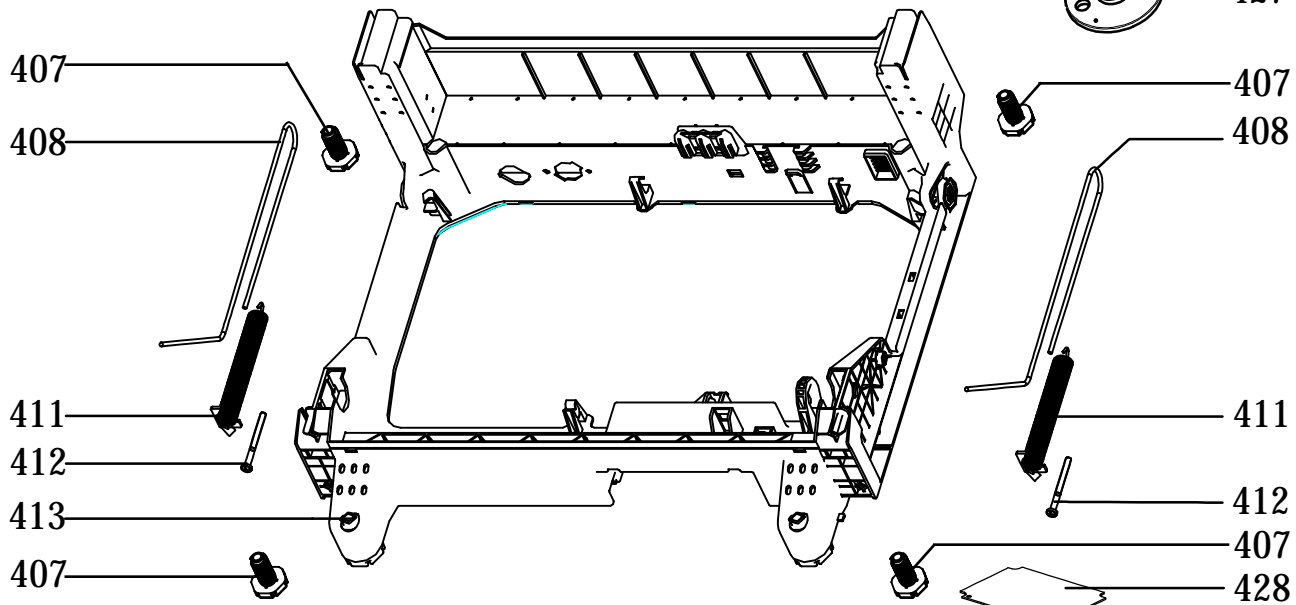

D

D

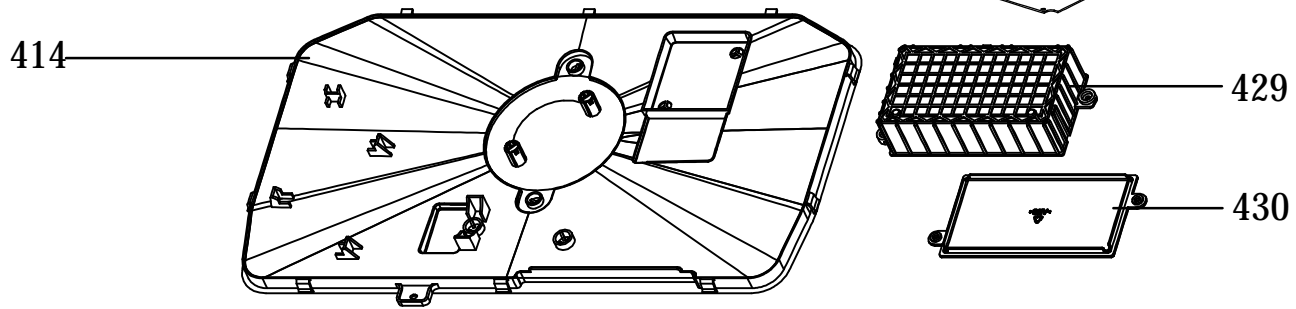

E

E

F

F

1

2

3

4

1

2

3

4

A

A

B

B

C

C

D

D

E

E

F

F

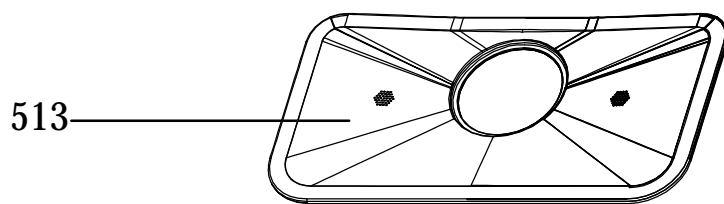
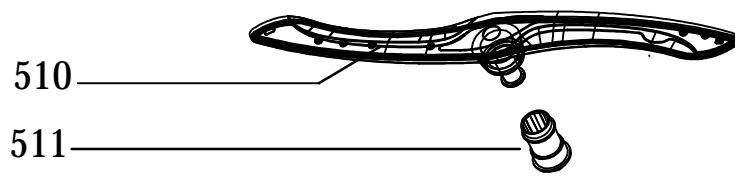
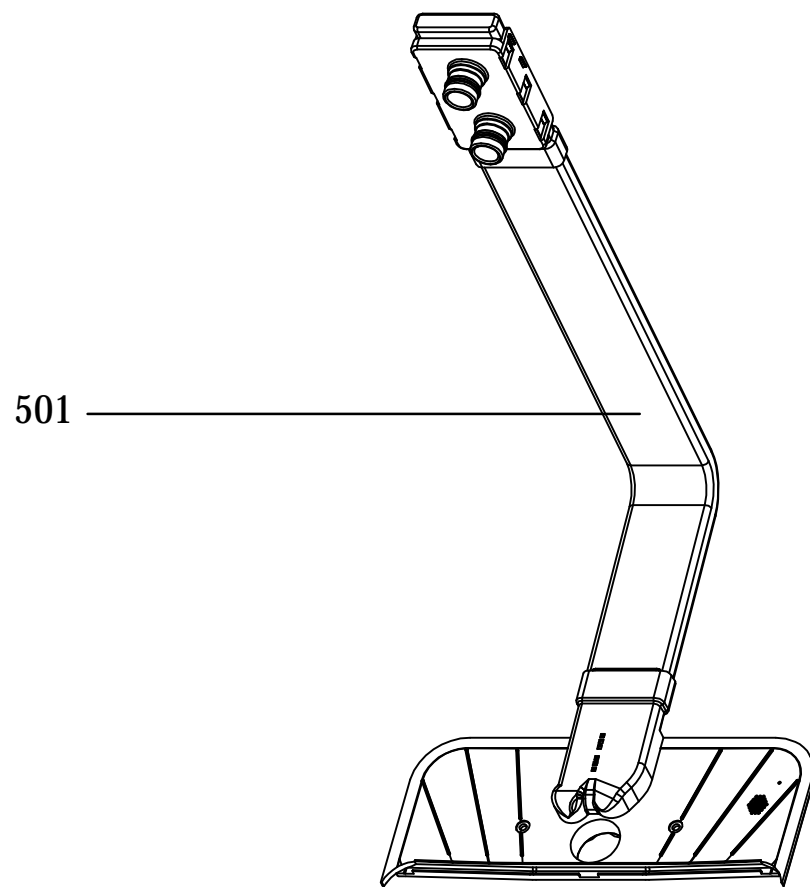

1

2

3

4

1

2

3

4

A

A

601

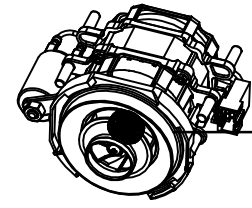
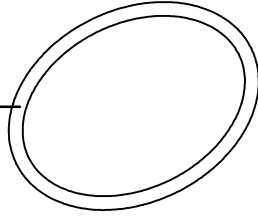

614

B

B

604



605

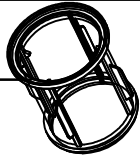

606



607

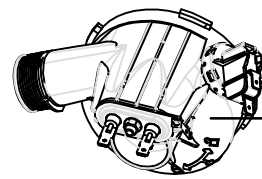

618

C

C

610

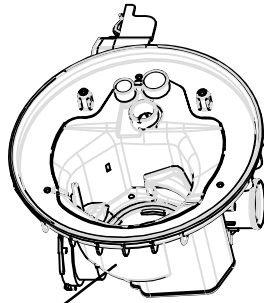
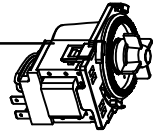

611

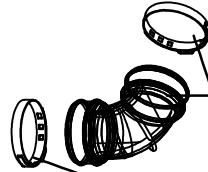

624

625

612

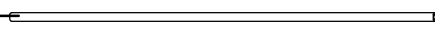

613

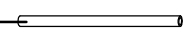

628

629



D

D

E

E

F

F

1

2

3

4

1

2

3

4

A

A

B

B

C

C

D

D

E

E

F

F

1

2

3

4

701

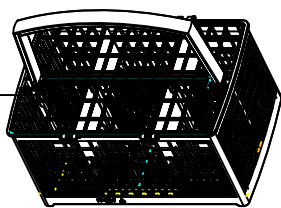

702

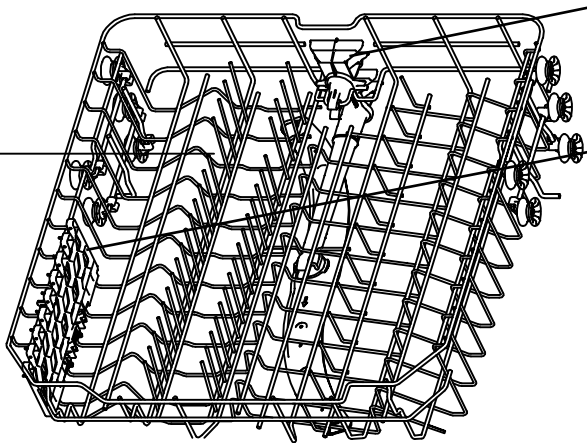

704

705



710



711

703

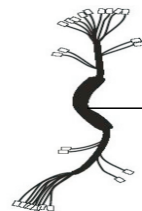
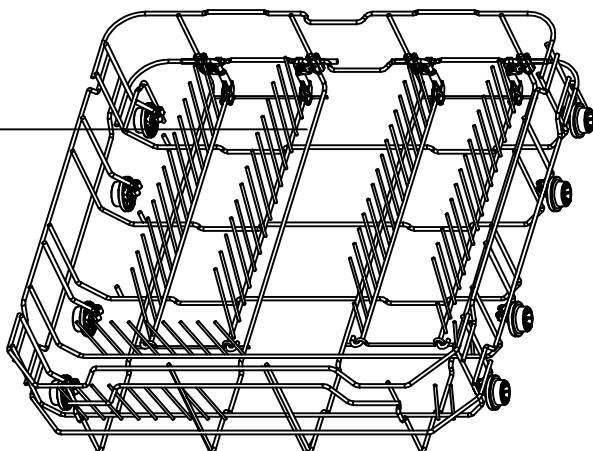

712